

Fire Door fitting instructions

Read through the Instructions thoroughly before commencing any work

Check the structural opening size against the door set, it is recommended that there is a 5mm clearance gap all the way around the outer edge of the frame.

Work in accordance with the sites manual handling policy, it is advised that two persons lift, move and position the door set.

Figure 1

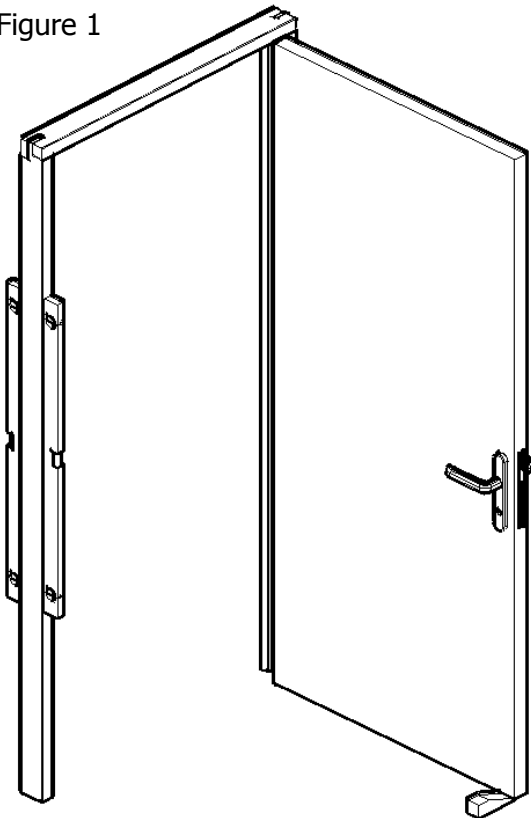

Place the door and frame in structural opening and then open the door 90 degrees. Position a suitable packer beneath the opening edge of the door leaf, ensure the hinge side of the frame is plumb to both internal and external faces using a spirit level.

If the floor is not level, fit packers under the jambs.

Pack the hinge side of the frame ensuring the frame is plum and square, check that the leg is not bowed.

Figure 2

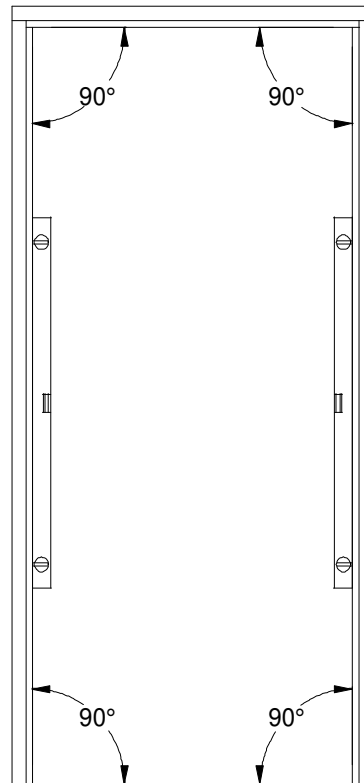

The positioning of installation fixings in height must be planned to avoid conflicts with the lock keeps, draught and intumescent fire seals.

Maximum of 600mm centres between fixings.

Figure 3

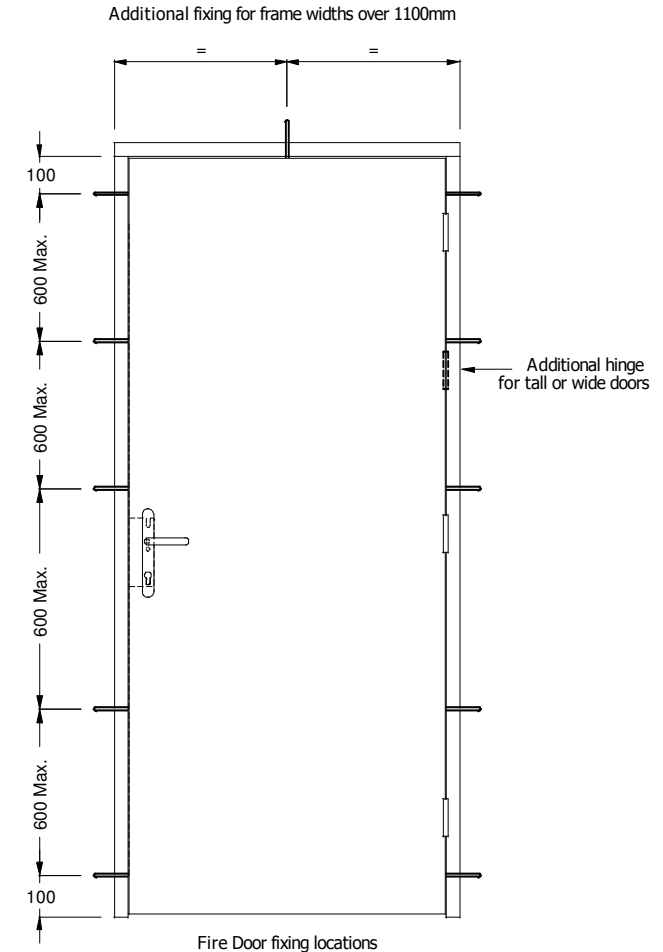

Ensure that frame is plumb, before fixing the hinge side of the door

Drill through the frame on the hinge side so that the fixings are in the intumescent groove, the fixings need to pass through the horse shoe packers.

Use Fischer or Rawlplug frame fixings 8 x 100 or similar that can be used on fire rated door sets and suit the wall substrate.

Steel horse shoe packers or suitably rated packers must be used on fire rated doors

Figure 4a FD30 frame

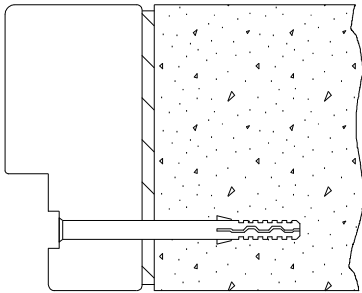
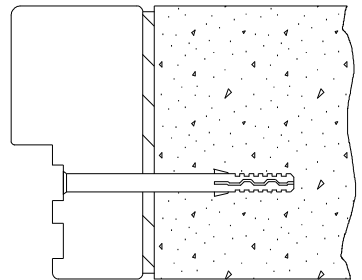
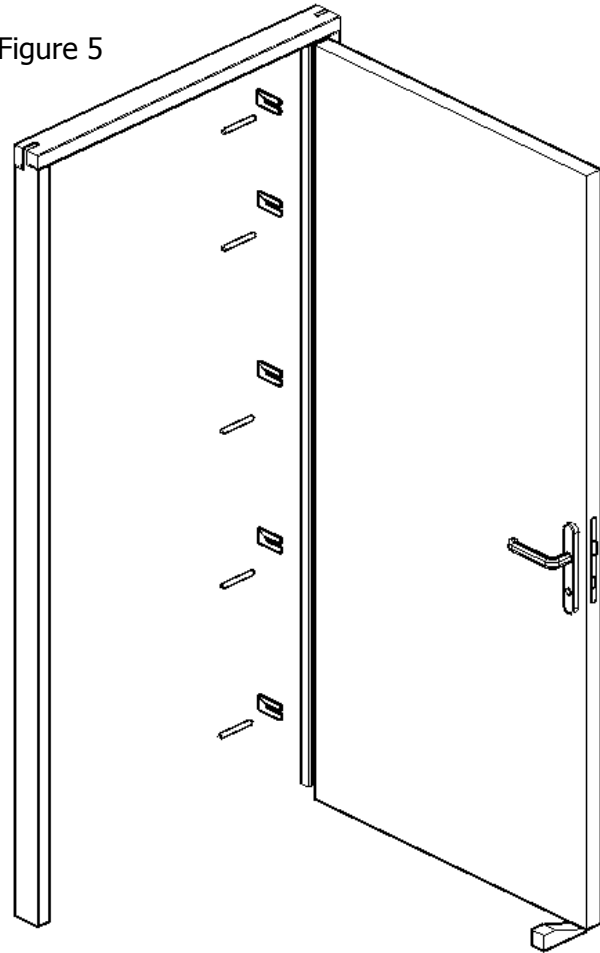

Figure 4b FD60 frame



Drill through the frame into the wall as shown in Figure 5 below, then loosely secure each frame fixing into the wall, then tap the horse shoe packers into position, before fully securing each frame fixing check that the frame has not moved out of square and is still plumb.

Figure 5



Drill through the frame on the lock side at the top of the frame as below in Figure 6 (see Figure 3 for dimensions), secure with a frame fixing and horse shoe packer.

Check that the frame is square and plumb as shown in Figure 1 and Figure 2

Figure 6

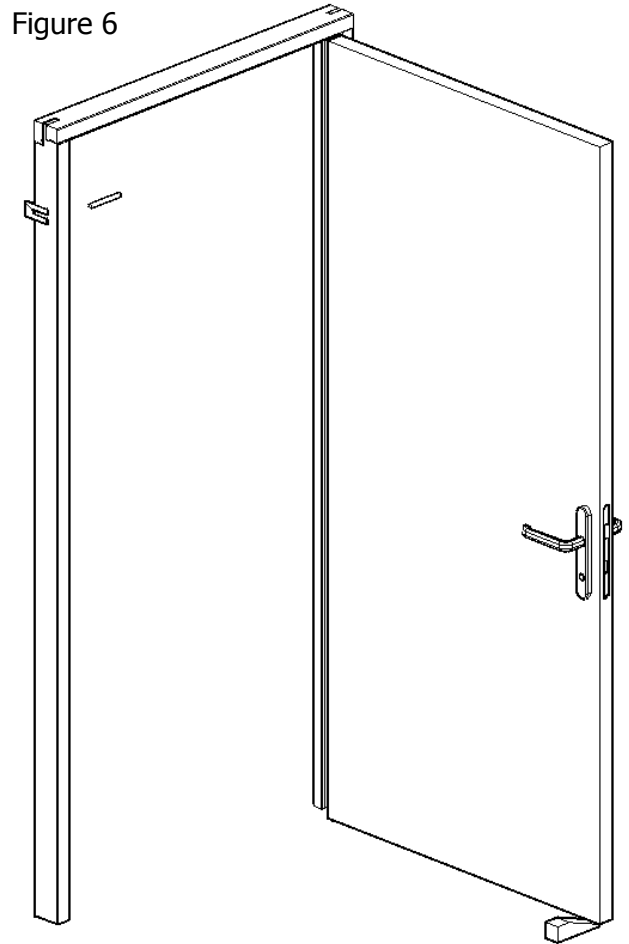

With the door almost closed, align the edge of the door with the edge of the frame, so that the gap is the same from the top to bottom of the door.

Figure 7

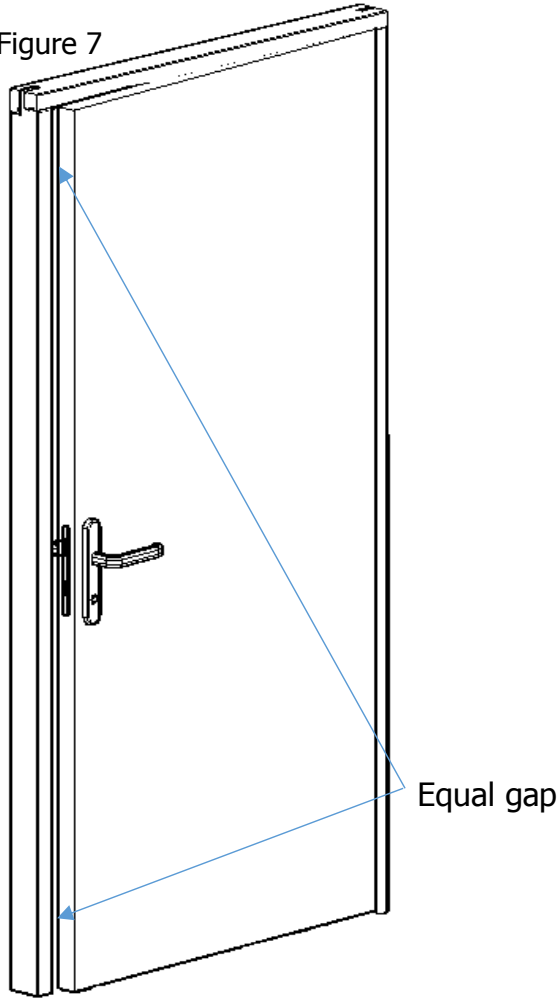

Repeat this procedure after each frame fixing point, this will allow for any possible bow or twist of the door leaf.

Figure 8

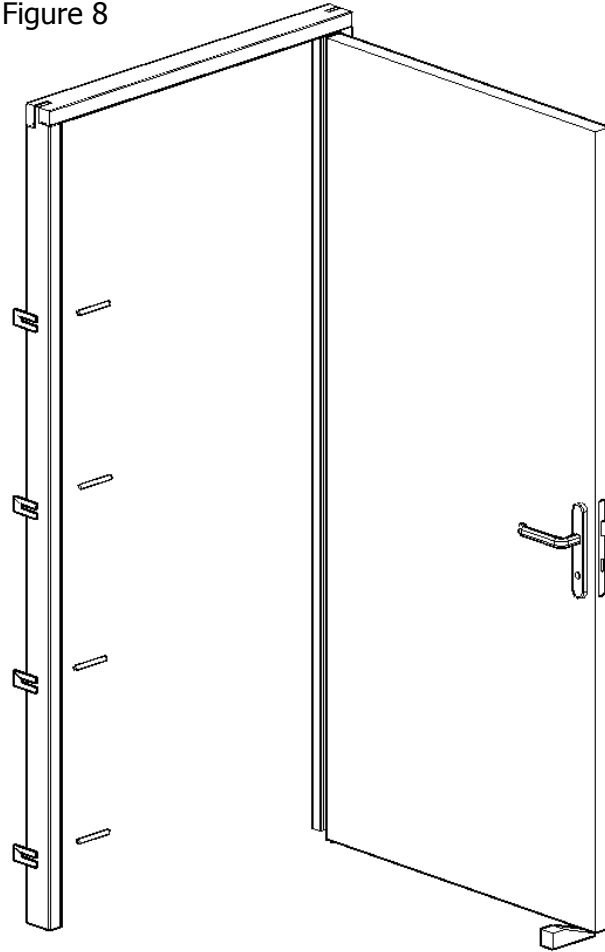

When all fixings are secured, the nominal gaps should be as shown in Figure 9

If fitting a lock (Certifire CE marked) ensure the relevant intumescent is fitted as per manufactures instructions.

Check the operation of the lock
Adjust the lock keep to ensure that the lock latches correctly

Figure 9

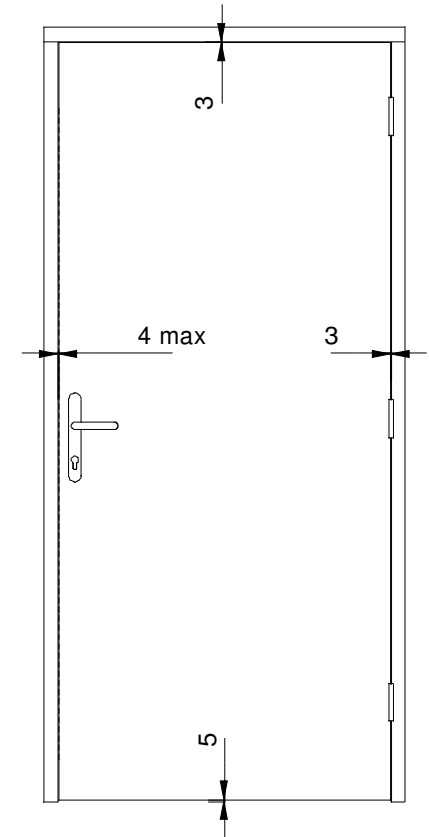

Apply an intumescent mastic sealant between the frame and the structural opening all around the frame, including under the cill if packing was required.

Fit intumescent into the grooves in frame

If a Drop Seal is fitted adjust as required

Fit face fix overhead door closer as per the manufactures instructions, perko type closers are not permitted.

Certifire approved door closers must be used and it is recommended that Certifire approved intumescent mastic sealants are used.